











## Unpacking

Before you start using the device, please check the version you got and ensure that the following items are included in the shipped box:

-  Plastic wall anchor x 4
-  ST4x20 crosshead screw x 4
-  Diode x 2
-  M3x6 crosshead screw x 1
-  M3x10.5 hex socket screw x 1
-  Allen wrench x 1
-  10-Pin cable x 1
-  11-Pin cable x 1
-  C319X x 1
-  Wall-mounting bracket x 1
-  M4x30 crosshead screw x 4

## Product Overview

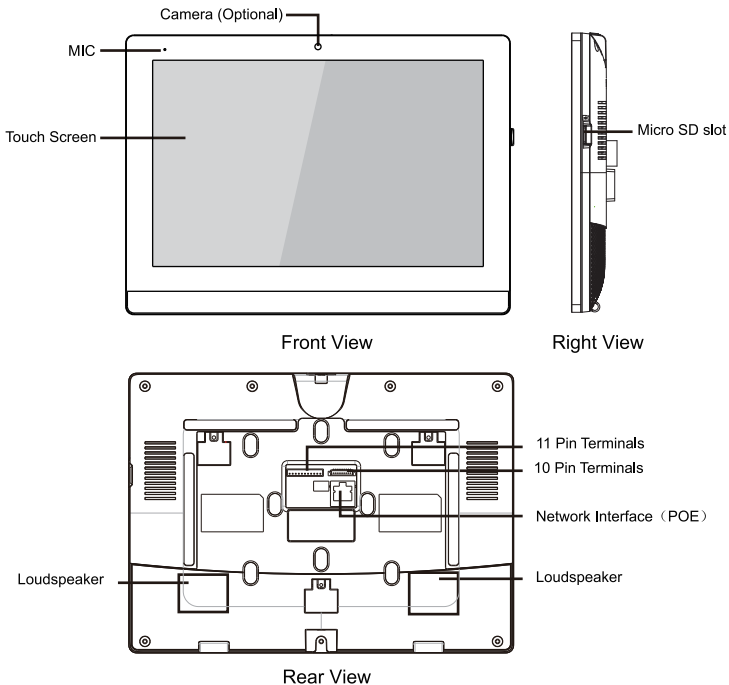

## Installation

### Step 1: Wall-mounting Bracket Installation

#### Without embedded box in the wall

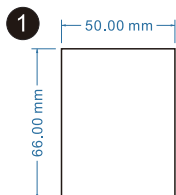

According to the position of the cable in the wall, dig out a square hole (height\*width\*depth = 66\*50\*50 mm) that can accommodate all cables.

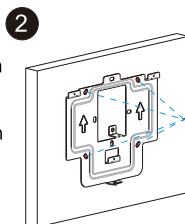

Align the square hole of the wall-mounting bracket with the hole dug out before, then mark the four fixation holes through wall-mounting bracket on the wall.

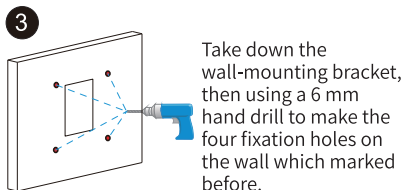

Take down the wall-mounting bracket, then using a 6 mm hand drill to make the four fixation holes on the wall which marked before.

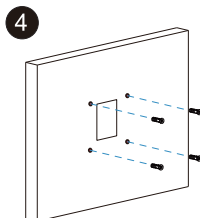

Once the fixing holes were made, insert plastic wall anchors.

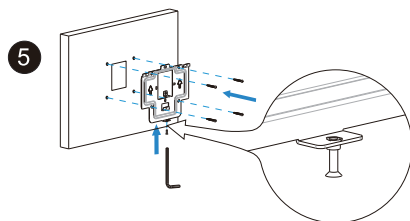

Twist M3x10.5 hex socket screw into the bottom hole of the wall-mounting bracket until the tail of which align to the edge. Then fix the wall-mounting bracket on the wall with four ST4x20 crosshead screws. If there is a ground wire to be connected, use M3x6 crosshead screw to fix it on the wall-mounting bracket.

#### With embedded box in the wall

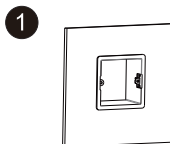

Make sure all cables in the embedded box.

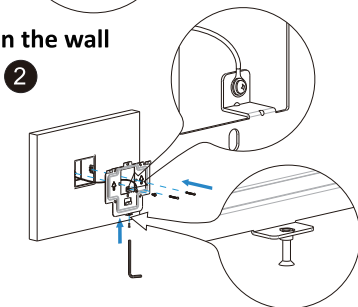

Twist M3x10.5 hex socket screw into the bottom hole of the wall-mounting bracket until the tail of which align to the edge. Then fix the wall-mounting bracket on the wall with two M4x30 crosshead screws. If there is a ground wire to be connected, use M3x6 crosshead screw to fix it on the wall-mounting bracket.

# C319X Quick Guide

## Step 2: Device Mounting

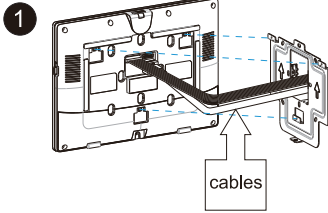

Connect the cables to device.

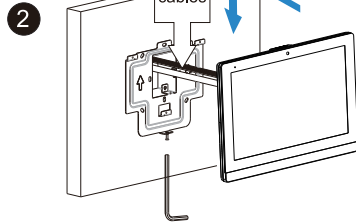

Push down to fix the device securely. Tighten M3x10.5 hex socket screw on the device with Allen wrench.

## Device Wiring

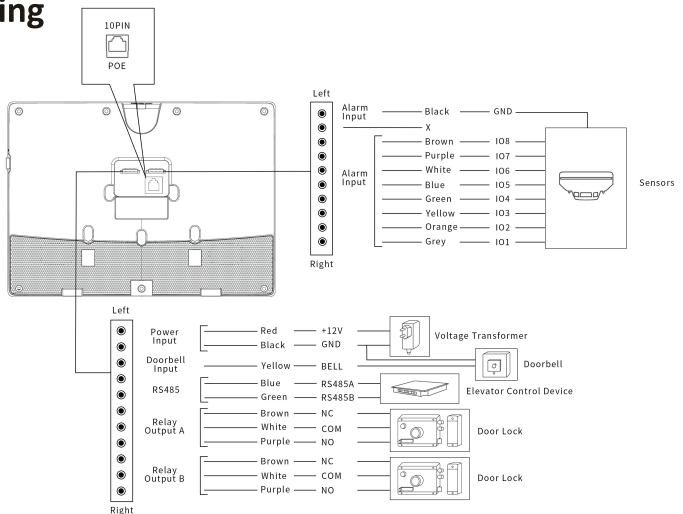

### ⚠ Warning

When you connect a device containing a coil, such as a relay or an electromagnetic lock, it is necessary to protect the intercom against voltage peak while switching off the induction load. For this way of protection we recommend a diode 1 A / 200 V (included in the accessories) connected antiparallel to the device.

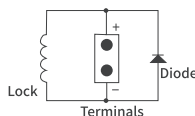

## Application Network Topology

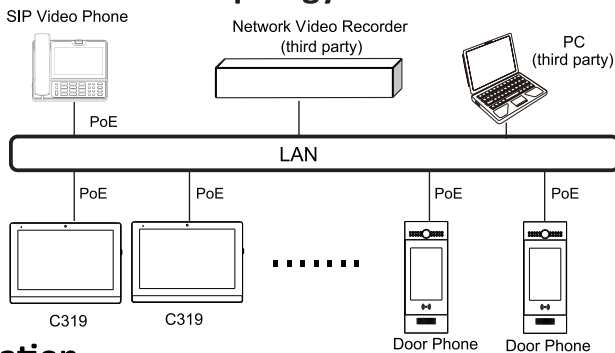

## Configuration



1. Access basic information: After setting up network and power, enter Setting > System Info to check Account, Network, Version status.
2. Access the Website: Launch a browser and type in the IP address then enter the username and password to login. (username/password: admin /admin by default)
3. Account Registration: On web UI, go to the path: Account > Basic page to fill in the account information, click Submit to confirm. (Please refer to user manual for more information)

## Operation

### Make a call:

Enter the callee's number or room address, then press **Dial**  icon to make an audio call or press **Video**  icon to make a video call. Press  icon to hang up.

### Receive a call:

Press  icon to pick up the incoming call in video mode or press  icon to pick up the call in audio mode.

### Unlock:

During the talk, you can press the **Unlock**  icon on the talking interface to unlock the door.

### Monitor:

Press the **Monitor**  icon to receive the video from the door phone or from third-party devices.

### Notice Information

Information contained in this document is believed to be accurate and reliable at the time of printing. This document is subject to change without notice, any update to this document can be viewed on Akuvox's website: <http://www.akuvox.com> © Copyright 2022 Akuvox Ltd. All rights reserved.



**AKUVOX (XIAMEN) NETWORKS CO., LTD.**

Addr: 10/F, NO.56 GUANRI ROAD, SOFTWARE PARK II, XIAMEN 361009, CHINA

[www.akuvox.com](http://www.akuvox.com)



YS3190000