



**Intelligent Background
Music System
Ceiling Speaker
Wall Mount Speaker**



Background Music
Wall Mount Amplifier



Smart Home
Audio System





Smart Music Controller Model:A7

Wifi Bluetooth Wall Amplifier Support TUYA

Bluetooth: Version 5.0

Power Input: AC110-250V

Audio Input: AUX input, one set

Audio Output: one set

Active Subwoofer Output: one set

HD MI Output: High Resolution Video output HD 1080P, Same screen display

IR Remote Control: Support

Audio format: MP3, WAV, WMA, FLAC, APE, AAC, AC3, OGG etc.

Video format: MPEG-1/2/3/4 ,RM/RMVB, WMV, MOV, MK, VOB, AVI, 3GP, H, 264, etc

Feature: support TUYA, TikTok, Spotify, BluetoothPlay, Smart Youtube, Go Keyboard, Pandora, etc.

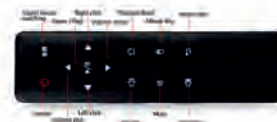

Installation Instructions



1. Pre-embed attached 175*110*60MM back cover. Back cover depth is 60mm.
2. Tighten the bracket with the bracket screw on the back cover.
3. Tighten the wire inside the back cover to the corresponding function terminal on the device. Then insert the terminal into the terminal post. Then put the device into the bracket and push down.
4. Wires used in this product: multi-strand copper wire, coaxial cable, audio cable, speaker cable.
5. Please consult the supplier when installing this machine. Do not repair the device without authorization. If you need to repair it, please consult the supplier and have it repaired by qualified personnel

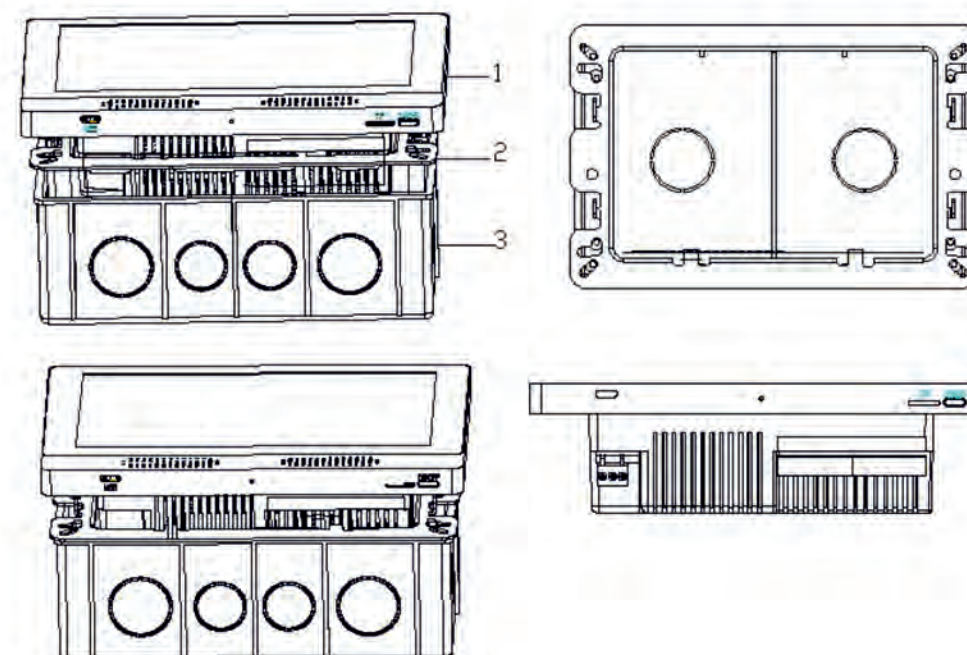

Basic Parameters

Product	7" in-wall amplifier	Resolution	1024*600 IPS
System	Android 8.1	CPU	Quad core Cortex 1.5GHZ
RAM	2GB	ROM	16GB
Power Supply	AC110-250V	Output Power	8*30W£ MAXE ©
Output Impedance	4-8 ohms	THD	0.03%(1W,1KHZE ©
Frequency Response	20Hz-20KHz	Audio S/N Ratio	98dB
Remote Control	Support	Wi-Fi	Support
Wire Box	110*175*59MM	Product Size	129*184.6*10.5MM

FEATURES:

- 1- System
 - Operation System: Android 8.1 System
 - CPU Model: Quad-core Cortex-A35
 - CPU Frequency: 1.5GHZ
- 2- Screen
 - Main screen size: 7 inch
 - Resolution: 1024*600
 - Material: IPS(full view)
 - Touch Screen: Multi-touch capacitive screen
- 3- Storage
 - RAM memory: 2GB
 - ROM: 16GB
 - USB: 2.0 port,can read 32G
- 4- Network
 - Wired port: not support
 - WIFI: support
- 5- Amplifier
 - Output Power: 8*20W(Ya maha digital amplifier)
 - Output impedance: 4-8 ohm
 - Total harmonic distortion: 0.03%(1W.1KHZ)
 - Frequency response: 20Hz-20KHz
 - Audio signal to noise ratio: 98db
 - Zone: Two Zones of speaker volume independent adjustment
 - Speaker: Eight-channel speaker output
 - Sound Effect: Built-in DSP 10 kinds of sound effect adjustment, compatible with branded speakers such as JBL, HiVi etc.

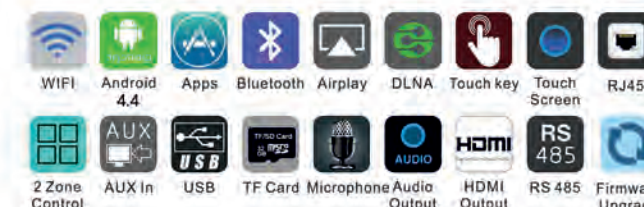

TF card direct reading



Easily save a lot of music through TF card,
read it internally, play it with your heart.



Model:FG-225

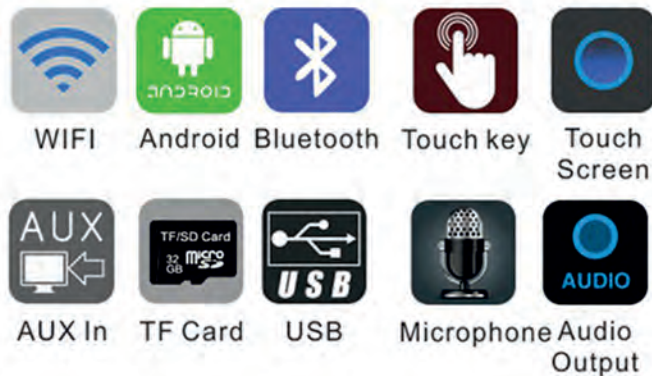

TF Card USB Bluetooth Controller Home Mini Audio Amplifier TV Background Smart Music Touch Key USB Bluetooth Controller



Bluetooth



Touch button



Set open close



Radio function



Music lossless decou



Golden



Black



White

Parameters:

- 3-inch Display,480*480 Resolution
- Key Touch
- Power Supply Mode: AC 110-250V
- Output Power: 4*20W (Digital power amplifier)
- Audio Inputs one set; Output one set
- Video Player
- Timing output: one set
- Bluetooth: 4.0
- Bluetooth working distance: 10 meters
- Infrared remote control distance: 10 meters
- Frequency response: 20Hz-20KHz
- T.H.D: 0.03%
- SNR: >=98dB
- Installation: 86 standard wire box, front wall
- Product size: 86*86*11mm
- Wire Box Opening Size: 86*86*57mm





Function Description:

- Radio Function
- Support TF card, USB Play
- 2-channel Speaker Output
- Support departure doorbell
- Multi-stage timing switch, music play, linkage control of smart home
- Supporting power-off memory, power-on and trigger music play
- DSP Sound Regulation
- Remote control operation
- High permeability and high hardness crystal panel, digital full-color highlight 3 inch TFT display
- Audio format: support MP3, WAV, WMA, FLAC, APE, DTS, AAC, AC3, OGG and other audio formats, support LRC lyrics show.
- Video format: support MPEG-1/2/3/4, RM/RMVB, WMV, MOV, MK, VOB, AVI, 3GP, H.264 and other video.
- Bluetooth function: support for mobile phones and other external Bluetooth device pairing to achieve audio playback, support for Bluetooth manual opening and automatic opening (suitable for hotel use).
- The external sound input: support external audio input, enlarge the output.

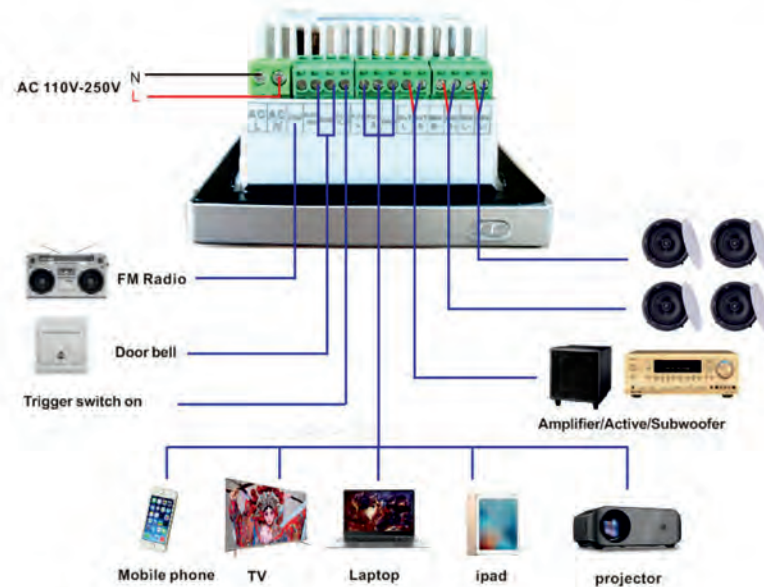

Application



living room



coffee shop



Beauty Shop



office



rest room

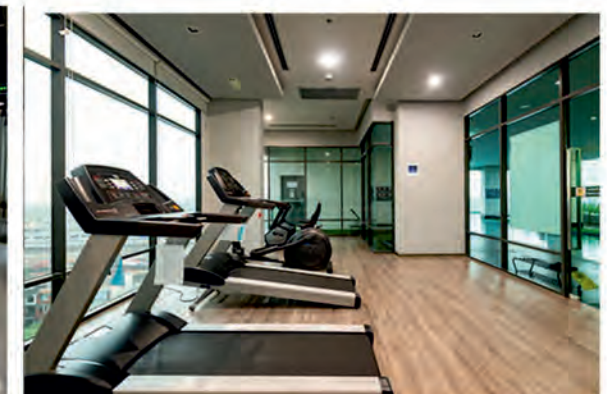

gym





Wall Mount Speaker





Model:FT-206

High Sound Quality 40 Watts 8 ohm HiFi Coaxial in Wall Mount PA Sound System

Description:

The FT-206 is a wall mount speaker built-in 70V/100V transformer. The 70V/100V transformer technique reduces line losses on longer distance and allows easy parallel connection of multiple loudspeakers. The built-in 4"+1" two ways speaker driver is designed of wide frequency response 100-15KHz, the multiple power taps 40W are helpful for different applications varies from room size and ambient noise surroundings. The Metal grille, ABS enclosure and stainless mounting bracket are of white or black color. Easy and secure wall-mounted installation through the supplied stainless mounting bracket. It is ideal choice for industrial and commercial applications in Conference rooms, business centers, exhibition centers of hotel, school and factory where background music and paging is needed.

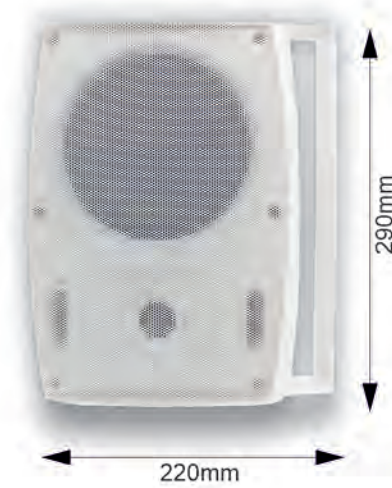

Model:FT-208

High Sound Quality 100 Watts 8 ohm HiFi Coaxial in Wall Mount PA Sound System

Description:

The FT-208 is a wall mount speaker built-in 70V/110V transformer. The 70V/100V transformer technique reduces line losses on longer distance and allows easy parallel connection of multiple loudspeakers. The built-in 4"+1" two ways speaker driver is designed of wide frequency response 100-15KHz, the multiple power taps 100W are helpful for different applications varies from room size and ambient noise surroundings. The Metal grille, ABS enclosure and stainless mounting bracket are of white or black color. Easy and secure wall-mounted installation through the supplied stainless mounting bracket. It is ideal choice for industrial and commercial applications in Conference rooms, business centers, exhibition centers of hotel, school and factory where background music and paging is needed.

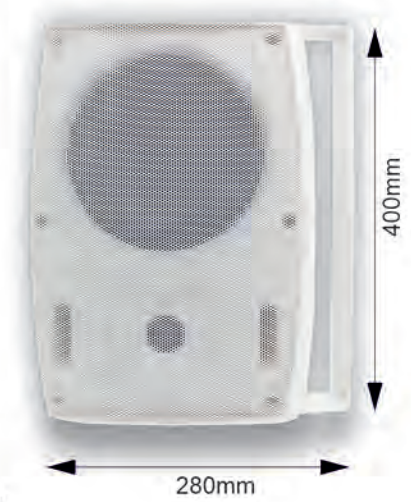

Model	FT-206
Description	Two Way Wall-Mounted Loudspeaker "5
Power Taps @100V	40W
Line Input	100V
Transformer Impedance	Black: Com, Red: 333Ω
Frequency Response	100-15KHZ
SPL(@1W/1M)	90db
Speaker Unit	woofer and 1" tweeter, two way speaker unit "5
Material	Metal grille, ABS enclosure and stainless mounting
Color	White or Black
Mounting Method	Easy installed by supplied stainless mounting bracket
Net Weight	2.5 kg
Dimension	290x220x150mm
Gross Weight	12KG

Model	FT-208
Description	Two Way Wall-Mounted Loudspeaker "5
Power Taps @100V	100W
Line Input	110V
Transformer Impedance	Black: Com, Red: 333Ω
Frequency Response	100-15KHZ
SPL(@1W/1M)	90db
Speaker Unit	woofer and 1" tweeter, two way speaker unit "5
Material	Metal grille, ABS enclosure and stainless mounting
Color	White or Black
Mounting Method	Easy installed by supplied stainless mounting bracket
Net Weight	3.8 kg
Dimension	400x280x230mm
Gross Weight	18KG



Ceiling speaker FG-618

Instruction



In-Ceiling Loudspeaker 6.5"-8 ohm

Revel in-ceiling loudspeakers draw upon the same research, resources, and unique perspectives that put all our loudspeakers in a class by themselves. Each model offers a standard-setting low sonic coloration and freedom from distortion over a wide dynamic range.

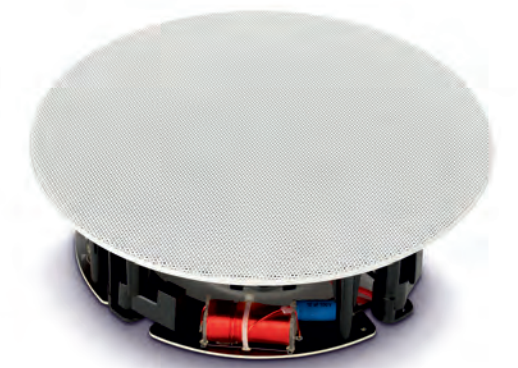
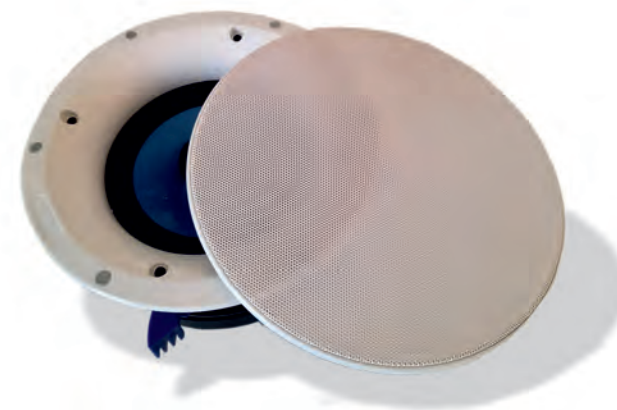

Specification:

Model	FG-618
Description	6.5" Waterproof Ceiling Speaker
Rated Power Output	50W-100W
Line Input	100V
Frequency Response	55-20KHz
SPL(@1W/1m)	92dB
Speaker Unit	6.5" coaxial waterproof PP driver unit
IP Rate	IP55
Material/Color	Stainless painted steel enclosure and steel grille in white
Mounting Method	Flush mount in-ceiling by spring clip
Cutout Size	Φ200mm
Product Dimension	Φ240x150mm



Ceiling speaker FG-585C

Instruction



In-Ceiling Loudspeaker 5" -8 ohm

Revel in-ceiling loudspeakers draw upon the same research, resources, and unique perspectives that put all our loudspeakers in a class by themselves. Each model offers a standard-setting low sonic coloration and freedom from distortion over a wide dynamic range.

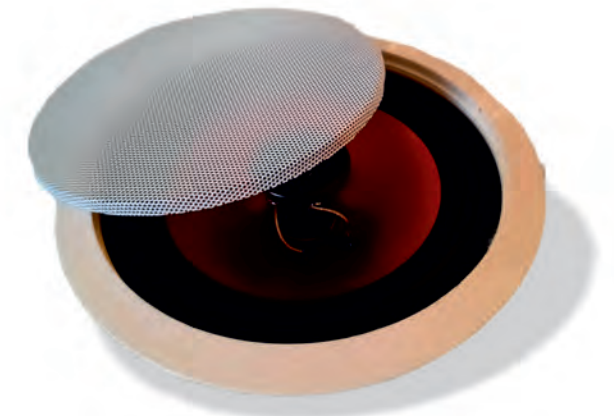
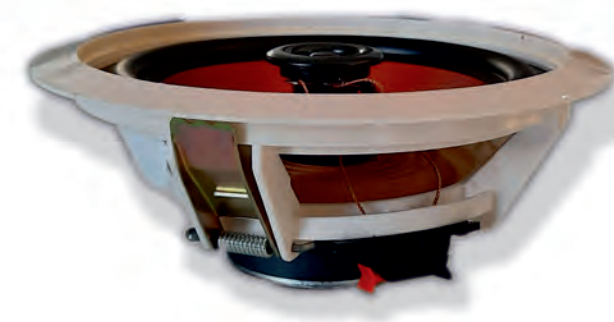
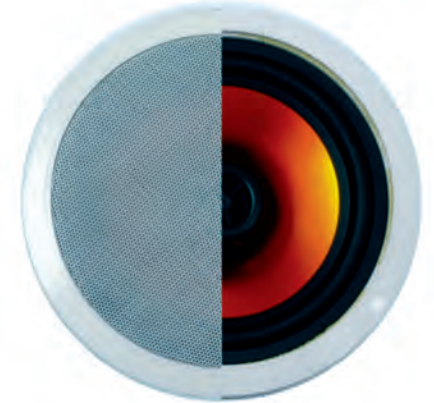

Specification:

Model	FG-585
Description	5" Waterproof Ceiling Speaker
Rated Power Output	20W-50W
Line Input	100V
Frequency Response	65-20KHz
SPL(@1W/1m)	92dB
Speaker Unit	5" coaxial waterproof PP driver unit
IP Rate	IP55
Material/Color	Stainless painted steel enclosure and steel grille in white
Mounting Method	Flush mount in-ceiling by spring clip
Cutout Size	Φ200mm
Product Dimension	Φ240x150mm



Ceiling speaker FG-902TS

Instruction



The product description

Bluetooth active ceiling speaker

- 1: using the most advanced digital power amplifier circuit, high efficiency, low power consumption, heat dissipation is small, long service life.
- 2: quality than traditional analog power amplifier to be clear, pure and stereo.
- 3: external audio source and bluetooth audio input at the same time, the bluetooth audio source is preferred.
- 4: the speaker unit: 6 inch bass unit, using 60 * 32 * 10 Y30 ferrite magnets, 20 core copper braid ASV heat-resistant aluminum voice coil; 1 inch black got high unit, the use of ndfeb magnetic N35, 13 ASV heat-resistant aluminum tube voice coil of core copper braid.
- 5: exquisite workmanship, fashionable.

Default password: 0000

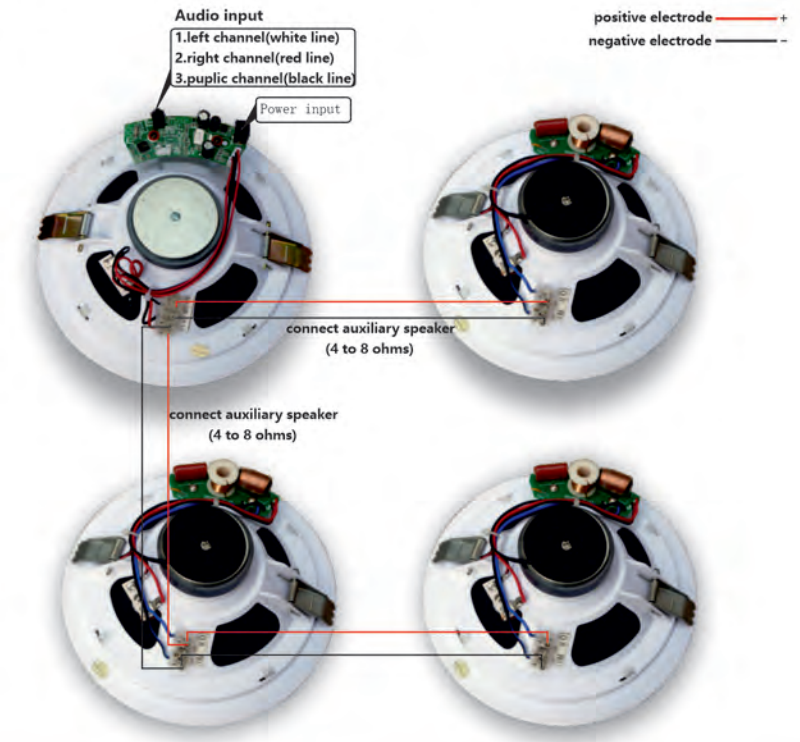
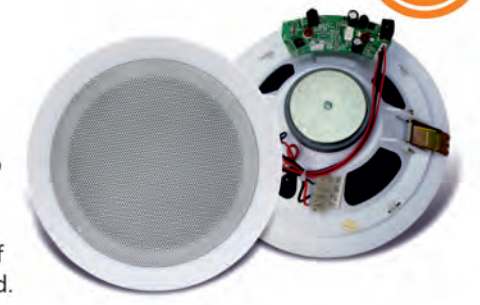

technical parameters :	FG-902TS
Drive	6 inch coaxial speaker
Speaker power	20W
Spirit acuity	92 db
Frequency response	110 hz - 20 KHZ
Power supply voltage	100V-220 v AC
Bluetooth version	Bluetooth 3.0
Amplifier power	2 * 20W dual channel stereo
Support for audio source	bluetooth audio source;The audio source
Radio frequency	796.5/798/799.5 MHZ
Transmission power	14 DBM - 16 DBM
Transmission distance	5 m to 10 m
The shell material	ABS + metal net + ABS plastic rear cover
Panel size	200 x 70 mm
Hole size	175 mm



Ceiling speaker FG-902S

Instruction



FG-902S PUBLIC ADDRESS SYSTEM

Feature:

- Commercial PA system music & paging in-ceiling speaker.
- Ideal background music for school, office, hotel & airport BGM & PA system.
- 6" full range PP driver unit.
- Rated Power 3W-6W at 100V.
- Line input 100V.
- ABS enclosure and ABS grille in White.
- Installation: Flush mount in-ceiling by spring clip.



The product description

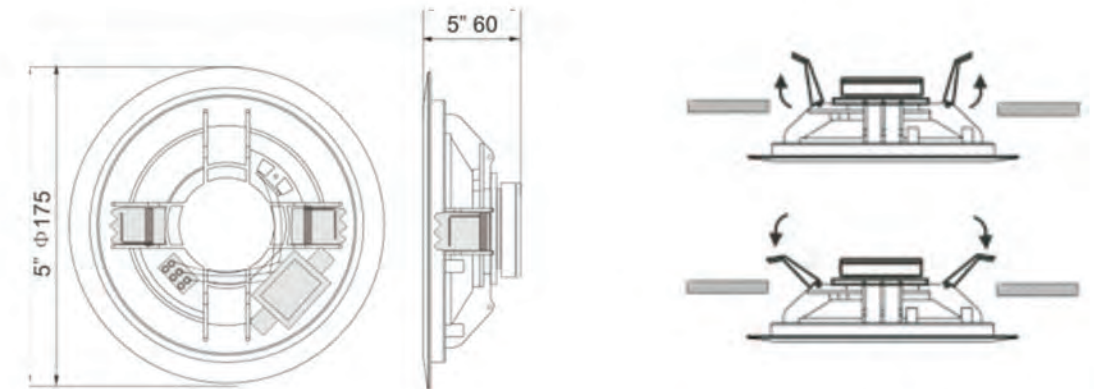

technical parameters :	LTH-902S
Drive	6 "
Speaker power	20W
Spirit acuity	92 db
Frequency response	100 hz - 20 KHZ
Power supply voltage	8ohms
material	ABS
Panel size	200 x 70 mm
Hole size	175 mm



Ceiling speaker FG-004

Instruction



PA 4" Indoor Pendant Speaker 7.5W 15W 100V 70V Ball Shape Suspension Projection in Ceiling Speaker

Rated Power (100V): 15W

Maximum Power: 30W

Input: 100V

Sensitivity (1W/1m): 98dB ± 3dB

Frequency Response: 100Hz-14KHz

Speaker Unit: 6.5 " x 1

Product size: Φ250 x460mm

Weight: 2.3KG

Standard rod length 250mm

Shell material: plastic shell

Packing specification: 545*280*535mm, 4pcs/ctn



technical parameters:	FG-004
Drive	4 "
Rated power	20W/10W/5W
Sensitivity	92 db
Frequency response	150 hz - 15 KHZ
Line voltage	70V-100V
Material	HIPS
Dimension	180X180 mm
Weight(Kg)	1.2



5W
20W
COM
10W



Ceiling speaker FG-603



Instruction

Waterproof Spot Mini Metal Coaxial Ceiling

Description:

The FG-603 is a Spot Mini Size in-ceiling speaker built-in 100V/70V transformer. The 100V/70V transformer technique reduces line losses on longer distance and allows easy parallel connection of multiple loudspeakers.

The built-in 3" or 4" coaxial paper driver unit is designed of wide frequency response 120-20KHz, power taps 3W-6W are helpful for different applications varies from room size and ambient noise surroundings.

The Metal grille, Metal outline border are of attractive white color. Its spring clip clamp flush mount in-ceiling type makes the easy and secure installation.

It is ideal choice for industrial and commercial applications in areas of school, train station, shopping mall, parking area, stadium, parks, playground, factory and airport where background music and paging is needed.

Rated Power (100V): 3W / 1.5W

Maximum Power: 6W

Input: 100V

Speaker Unit: 3"x1 woofer

Sensitivity (1W/1m): 89dB ± 3dB

Frequency Response: 130Hz-12KHz

Installation hole cutout size: Φ88mm

Product size: Φ100x70x88mm

Weight: 0.4KG

Material: plastic frame + iron mesh cover

Packing: 55.5*22.5*24cm, 20pcs/ctn



Specification:

Model	SP-603
Description	3" Waterproof Ceiling Speaker
Rated Power Output	3W-6W
Line Input	100V
Frequency Response	120-20KHz
SPL(@1W/1m)	87dB
Speaker Unit	3" coaxial waterproof PP driver unit
IP Rate	IP55
Material/Color	Stainless painted steel enclosure and steel grille in white
Mounting Method	Flush mount in-ceiling by spring clip
Cutout Size	Φ90mm
Product Dimension	Φ100x60mm
Net Weight	0.4KG/pc

WWW.FGSOUND.COM

